

# groël

## Swim

The warmth of a charming minimalism.

The Swim handle design for windows, has a simple and natural style and is presented on a rectangular mechanism. This Italian handle design is made in high quality forged brass, is conceived for windows in numerous finishes giving a wink to every lover of delicate curves on planes.

*Available in 3 finishes.*



POWERCOAT INOX



SATIN CHROME



POLISHED CHROME



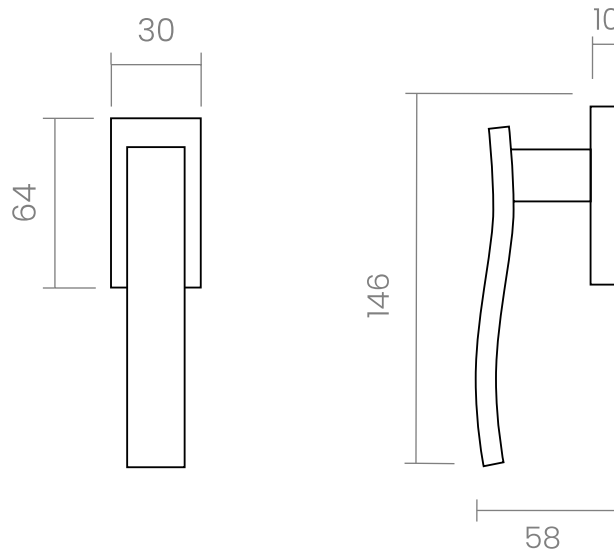



groël



### INFO. SPECIFICATIONS

A forged brass window handle with a rectangular rose with a window mechanism.

### INFO. FINISHES & SKU

 <b>CR</b>	Polished chrome	157-GC-CR	
 <b>CS</b>	Satin chrome	157-GC-CS	
 <b>PWIX</b>	Powercoat inox	157-GC-PWIX	

### INFO. INCLUDED

- 1x Window handle
- 1x Rectangular window mechanism
- 1x Bag of screws

### INFO. CARE INSTRUCTIONS

Clean with a dry cloth. Do not use brass cleaner as it might affect the protective coating.

### INFO. DISCLAIMER

Always seek the advice of professionals when installing these handles.  
Groël is not responsible for any inadequate installation that may damage the integrity of the product.  
Finishes other than Groël's Powercoat are not recommended for wet or humid environments.



Production processes follow ecological norms.



Mechanical guarantee far exceed 200.000 operational cycles



Made of solid brass



Chrome III  
15 YEARS GUARANTEE



Powercoat  
LIFELONG GUARANTEE