

# groël

# Tendenza

The sweetness herself made a handle.

The door handle design Tendenza with a contemporary style and perfect angles is presented on a round rose. This Italian design handle is made in high quality forged brass, is conceived for interior and exterior doors in several finishes, becoming a dreamy handle combining planes and curves.

*Available in 7 finishes.*



POWERCOAT SATIN BRASS



POWERCOAT INOX



POWERCOAT GRAPHITE



POLISHED CHROME



SATIN CHROME



POWERCOAT POLISHED BRASS



MATT BLACK

groël

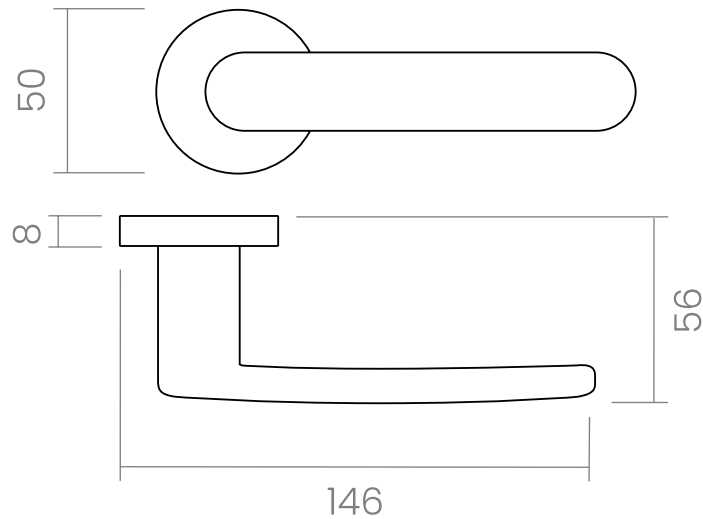















**INFO. SPECIFICATIONS**

Set of forged brass handles with an 8 mm thick round rose. Suitable for interior and exterior doors with a thickness between 35-50mm (Groël's standard size)\* and with any type of lock.

For wider doors (50mm and above) and/or glass doors, please contact our customer service.

**INFO. FINISHES & SKU**

|  |  |             |   |
|--|--|-------------|---|
|  | <b>PWLP</b>   Powercoat polished brass | 214-R8-PWLP |  |
|  | <b>PWLS</b>   Powercoat satin brass    | 214-R8-PWLS |  |
|  | <b>PWIX</b>   Powercoat inox           | 214-R8-PWIX |  |
|  | <b>PWGT</b>   Powercoat graphite       | 214-R8-PWGT |  |
|  | <b>CR</b>   Polished chrome            | 214-R8-CR   |  |
|  | <b>CS</b>   Satin chrome               | 214-R8-CS   |  |
|  | <b>BK</b>   Matt black                 | 214-R8-BK   |  |

**INFO. INCLUDED**

- 2x** Lever handles with round rose
- 1x** Square spindle
- 1x** Bag of screws

**INFO. CARE INSTRUCTIONS**

Clean with a dry cloth. Do not use brass cleaner as it might affect the protective coating.

**INFO. DISCLAIMER**

Always seek the advice of professionals when installing these handles. Groël is not responsible for any inadequate installation that may damage the integrity of the product. Finishes other than Groël's Powercoat are not recommended for wet or humid environments.

