

groël

Special

Discipline and purity fused in a single entity.

The Special door handle has a style denoting minimalism and is presented on an oval backplate. This Italian door handle design made in forged brass is conceived for interior and exterior doors in several finishes. Special, where the most refined curves converge with sweet horizontal surfaces.

Available in 7 finishes.



POWERCOAT POLISHED BRASS



POWERCOAT SATIN BRASS



POWERCOAT INOX



POLISHED CHROME



POWERCOAT GRAPHITE



SATIN CHROME



MATT BLACK

groël

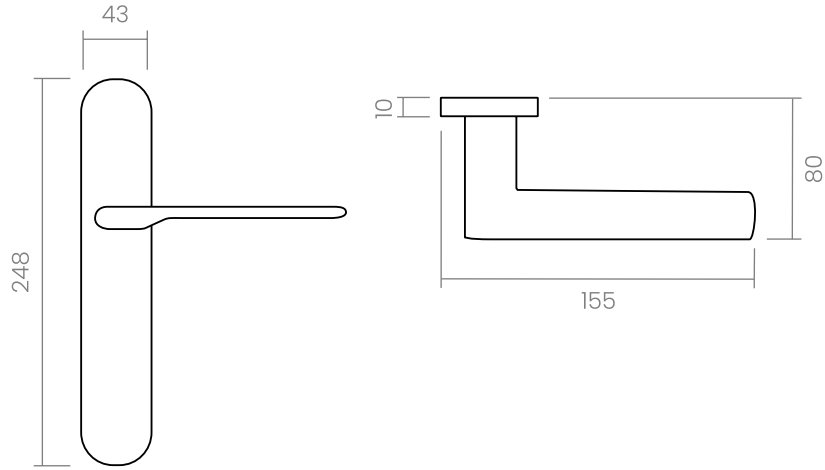

INFO. SPECIFICATIONS

Set of forged brass handles with an 10 mm thick oval backplate. Suitable for interior and exterior doors with a thickness between 35-50mm (Groël's standard size)* and with any type of lock.

For wider doors (50mm and above) and/or glass doors, please contact our customer service.





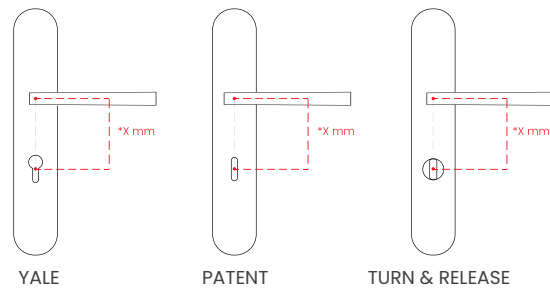









CAN I ADD ESCUTCHEONS OR PRIVACY TURN & RELEASE ON BACKPLATES?

Yes, you only have to tell us the type of escutcheon (yale or patent) or the type of privacy turn & release, and indicate the dimensions between centres*.



*X= Distance between centres

INFO. FINISHES & SKU

	PWLP Powercoat polished brass	247-P-PWLP	
	PWLS Powercoat satin brass	247-P-PWLS	
	PWIX Powercoat inox	247-P-PWIX	
	PWGT Powercoat graphite	247-P-PWGT	
	CR Polished chrome	247-P-CR	
	CS Satin chrome	247-P-CS	
	BK Matt black	247-P-BK	

INFO. INCLUDED

- 2x** Lever handles on an oval backplate
- 1x** Square spindle
- 1x** Bag of screws

INFO. CARE INSTRUCTIONS

Clean with a dry cloth. Do not use brass cleaner as it might affect the protective coating.

INFO. DISCLAIMER

Always seek the advice of professionals when installing these handles. Groël is not responsible for any inadequate installation that may damage the integrity of the product. Finishes other than Groël's Powercoat are not recommended for wet or humid environments.

