

groël

Ibiza

Close your eyes, feel the texture.

The door handle design Ibiza has a dynamic, ongoing and coherent style with a "zigrinato" grip assembled on a round rose; freshness and informality for your home. This Italian door handle design made in forged brass is conceived for interior and exterior doors in several es. The perfect stimulation of the island's lifestyle.

Available in 3 finishes.



POWERCOAT SATIN BRASS



POWERCOAT INOX



POWERCOAT GRAPHITE

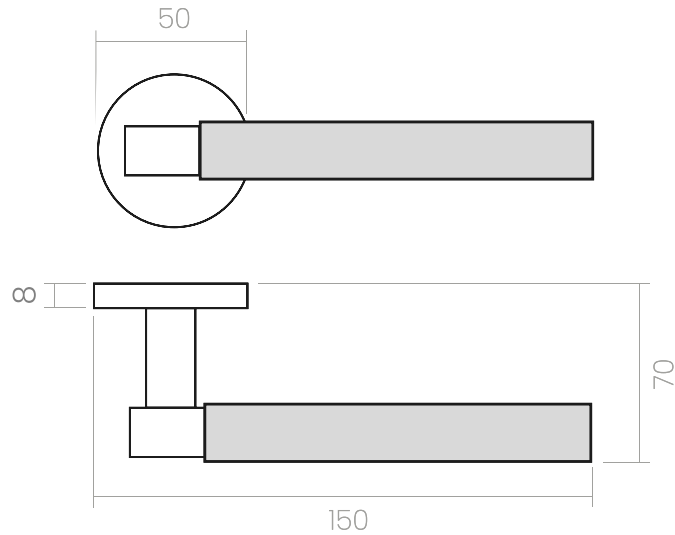







INFO. SPECIFICATIONS

Set of forged brass handles with an 8 mm thick round rose. Suitable for interior and exterior doors with a thickness between 35-50mm (Groël's standard size)* and with any type of lock.

For wider doors (50mm and above) and/or glass doors, please contact our customer service.

INFO. FINISHES & SKU

	PWLS Powercoat satin brass	256-R8-PWLS	
	PWIX Powercoat inox	256-R8-PWIX	
	PWGT Powercoat graphite	256-R8-PWGT	

INFO. INCLUDED

- 2x** Lever handles with round rose
- 1x** Square spindle
- 1x** Bag of screws

INFO. CARE INSTRUCTIONS

Clean with a dry cloth. Do not use brass cleaner as it might affect the protective coating.

INFO. DISCLAIMER

Always seek the advice of professionals when installing these handles. Groël is not responsible for any inadequate installation that may damage the integrity of the product. Finishes other than Groël's Powercoat are not recommended for wet or humid environments.



Production processes follow ecological norms.



Mechanical guarantee far exceed 200.000 operational cycles



Made of solid brass



Powercoat LIFELONG GUARANTEE