

groël

# New York

New York, there's nothing you can't do.

The New York design door handle, with its simple, bright and sleek style, comes on an exclusive backplate. This Italian design handle is made of forged brass and is designed for interior and exterior doors in several finishes. The Empire State style of this handle will inspire freedom.

*Available in 3 finishes.*



POWERCOAT POLISHED BRASS



POWERCOAT INOX



POWERCOAT POLISHED NICKEL

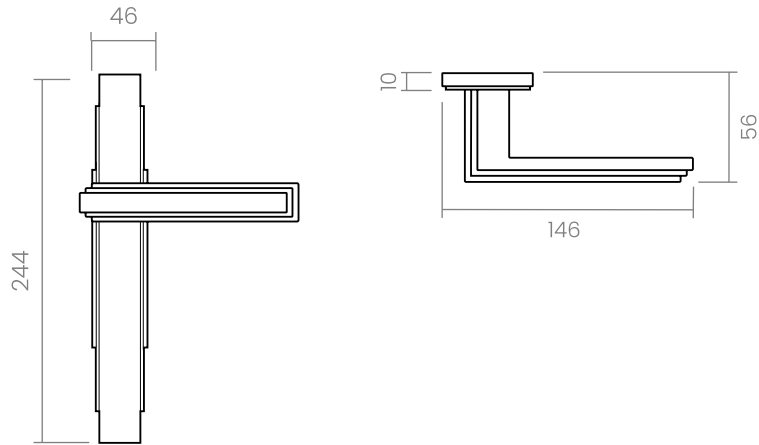

**INFO. SPECIFICATIONS**

Set of forged brass handles with an 10 mm thick exclusive backplate. Suitable for interior and exterior doors with a thickness between 35-50mm (Groël's standard size)\* and with any type of lock.

For wider doors (50mm and above) and/or glass doors, please contact our customer service.





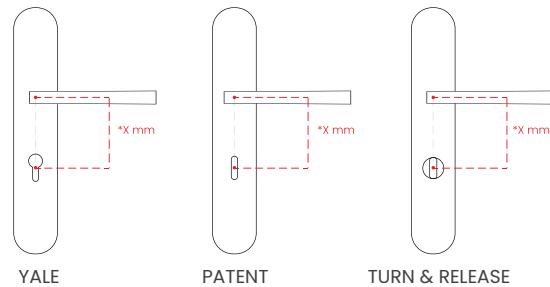

**CAN I ADD ESCUTCHEONS OR PRIVACY TURN & RELEASE ON BACKPLATES?**

Yes, you only have to tell us the type of escutcheon (yale or patent) or the type of privacy turn & release, and indicate the dimensions between centres\*.



\*X= Distance between centres

**INFO. FINISHES & SKU**

	<b>PWNB</b>   Powercoat polished nickel	555-PNY-PWNB	
	<b>PWLP</b>   Powercoat polished brass	555-PNY-PWLP	
	<b>PWIX</b>   Powercoat inox	555-PNY-PWIX	

**INFO. INCLUDED**

- 2x** Lever handles on an exclusive backplate
- 1x** Square spindle
- 1x** Bag of screws

**INFO. CARE INSTRUCTIONS**

Clean with a dry cloth. Do not use brass cleaner as it might affect the protective coating.

**INFO. DISCLAIMER**

Always seek the advice of professionals when installing these handles. Groël is not responsible for any inadequate installation that may damage the integrity of the product. Finishes other than Groël's Powercoat are not recommended for wet or humid environments.