

# groël

## New York

New York, there's nothing you can't do.

The New York design door handle, with its simple, bright and sleek style, comes on a squared rose. This Italian design handle is made of forged brass and is designed for interior and exterior doors in several finishes. The Empire State style of this handle will inspire freedom.

*Available in 3 finishes.*



**POWERCOAT POLISHED NICKEL**



**POWERCOAT INOX**



**POWERCOAT POLISHED BRASS**

groël

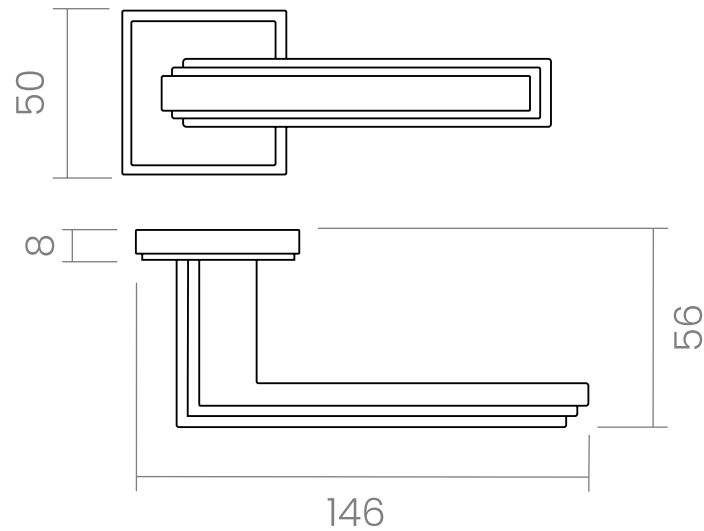







### INFO. SPECIFICATIONS

Set of forged brass handles with an 8 mm thick squared rose. Suitable for interior and exterior doors with a thickness between 35-50mm (Groël's standard size)\* and with any type of lock.

For wider doors (50mm and above) and/or glass doors, please contact our customer service.

### INFO. FINISHES & SKU

	<b>PWNB</b>   Powercoat polished nickel	555-R2C-PWNB	
	<b>PWLP</b>   Powercoat polished brass	555-R2C-PWLP	
	<b>PWIX</b>   Powercoat inox	555-R2C-PWIX	

### INFO. INCLUDED

- 2x** Lever handles with round rose
- 1x** Square spindle
- 1x** Bag of screws

### INFO. CARE INSTRUCTIONS

Clean with a dry cloth. Do not use brass cleaner as it might affect the protective coating.

### INFO. DISCLAIMER

Always seek the advice of professionals when installing these handles.  
Groël is not responsible for any inadequate installation that may damage the integrity of the product.  
Finishes other than Groël's Powercoat are not recommended for wet or humid environments.



Production processes follow ecological norms.



Mechanical guarantee far exceed 200.000 operational cycles



Made of solid brass



Powercoat LIFELONG GUARANTEE