

groël

Malika

Contemporary design of a classic.

The Malika door handle design presenting a brilliant harmony of consecutive lines and turned neck make, is assembled with a rectangular backplate. This Italian handle made in forged brass is conceived for interior and exterior doors in several finishes, promoting elegance, tradition and vanguard.

Available in 3 finishes.



POWERCOAT POLISHED NICKEL



POWERCOAT SATIN BRASS

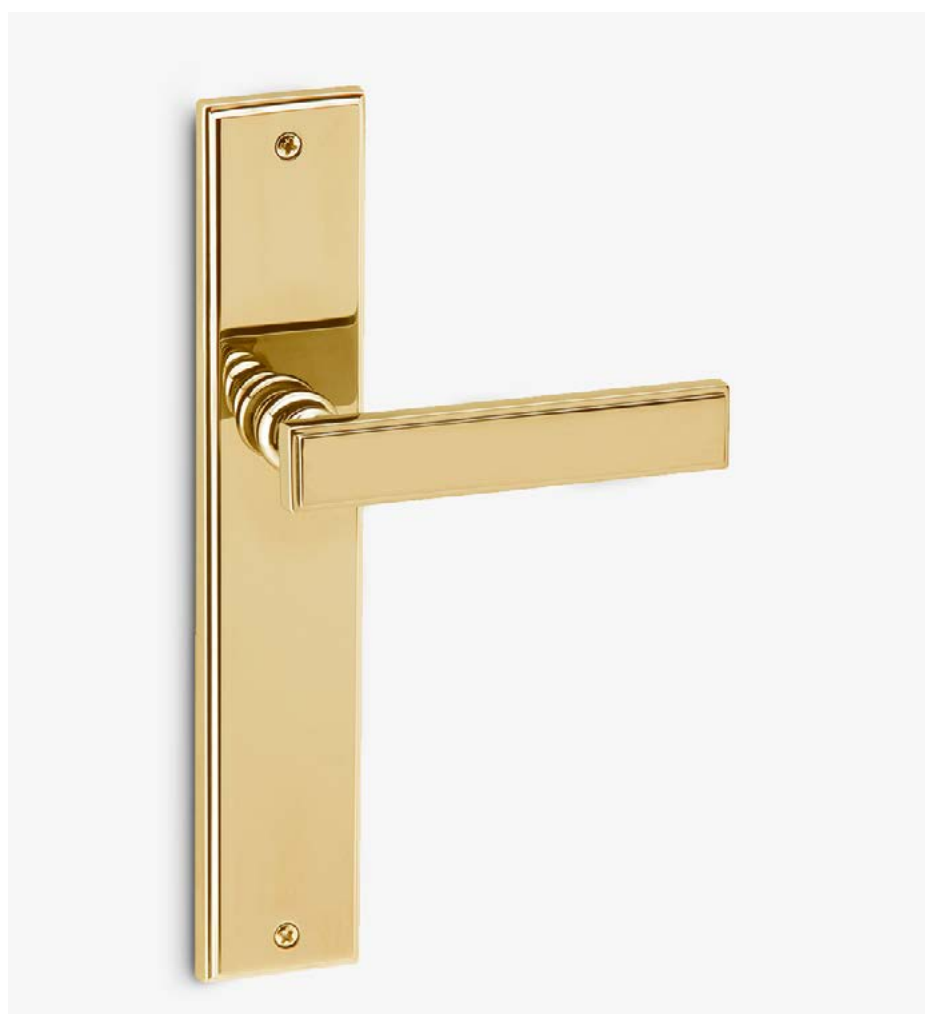

POWERCOAT POLISHED BRASS

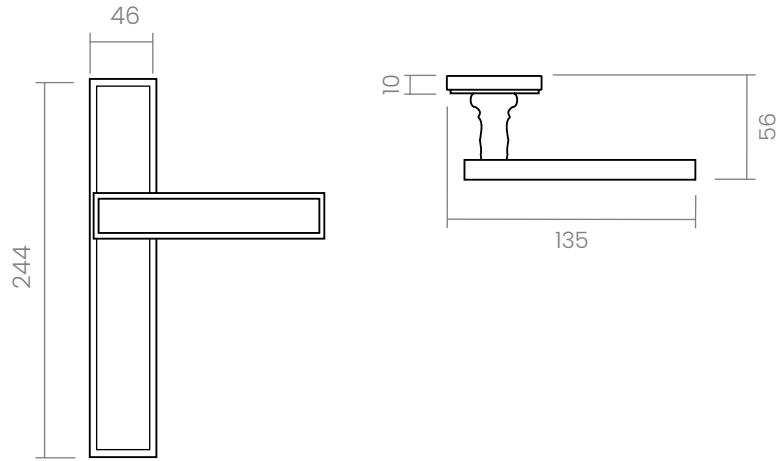

INFO. SPECIFICATIONS

Set of forged brass handles with an 10 mm thick rectangular backplate. Suitable for interior and exterior doors with a thickness between 35-50mm (Groël's standard size)* and with any type of lock.

For wider doors (50mm and above) and/or glass doors, please contact our customer service.





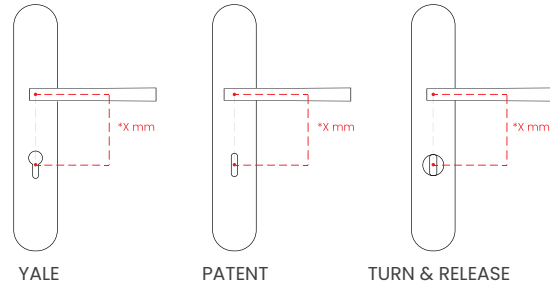

CAN I ADD ESCUTCHEONS OR PRIVACY TURN & RELEASE ON BACKPLATES?

Yes, you only have to tell us the type of escutcheon (yale or patent) or the type of privacy turn & release, and indicate the dimensions between centres*.



*X= Distance between centres

INFO. FINISHES & SKU

	PWNB Powercoat polished nickel	570-PC2-PWNB	
	PWLP Powercoat polished brass	570-PC2-PWLP	
	PWLS Powercoat satin brass	570-PC2-PWLS	

INFO. INCLUDED

- 2x** Lever handles on a rectangular backplate
- 1x** Square spindle
- 1x** Bag of screws

INFO. CARE INSTRUCTIONS

Clean with a dry cloth. Do not use brass cleaner as it might affect the protective coating.

INFO. DISCLAIMER

Always seek the advice of professionals when installing these handles. Groël is not responsible for any inadequate installation that may damage the integrity of the product. Finishes other than Groël's Powercoat are not recommended for wet or humid environments.