

groël

Espuch

The beauty of the pure symmetry of a hexagon turned into a handle. The Espuch door handle design has an origin and heart from Alicante. The renowned Alicante interior designer and founder of the Azul Tierra studio has been creating projects that combine luxury and sustainability for more than 20 years. Far from trends, in his aesthetic universe natural proportions coexist with the use of noble materials. This handle design is made of forged brass and is conceived for interior and exterior doors in three finishes.

Available in 5 finishes.



POWERCOAT GRAPHITE



POWERCOAT INOX



POWERCOAT SATIN BRASS



UNLACQUERED BRASS



OLD BRASS

groël

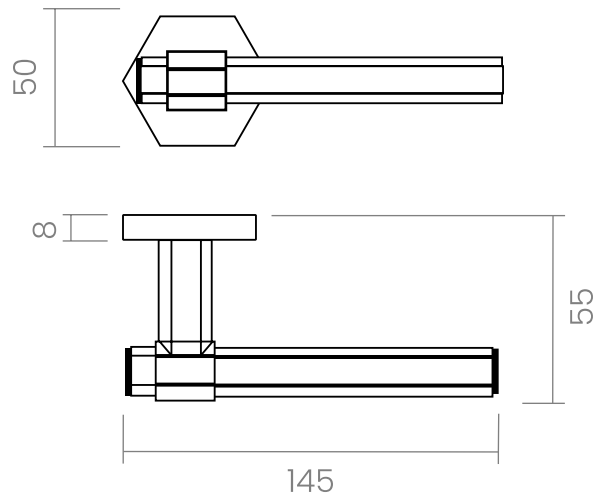











INFO. SPECIFICATIONS

Set of forged brass handles with an 8 mm thick special rose. Suitable for interior and exterior doors with a thickness between 35-50mm (Groël's standard size)* and with any type of lock.

For wider doors (50mm and above) and/or glass doors, please contact our customer service.

INFO. FINISHES & SKU

	PWGT <i>Powercoat graphite</i>	616-R6-PWGT	
	PWIX <i>Powercoat inox</i>	616-R6-PWIX	
	PWLS <i>Powercoat satin brass</i>	616-R6-PWLS	
	OB <i>Old brass</i>	616-R6-OB	
	LSB <i>Unlacquered brass</i>	616-R6-LSB	

INFO. INCLUDED

- 2x** Lever handles with special rose
- 1x** Square spindle
- 1x** Bag of screws

INFO. CARE INSTRUCTIONS

Clean with a dry cloth. Do not use brass cleaner as it might affect the protective coating.

INFO. DISCLAIMER

Always seek the advice of professionals when installing these handles.
Groël is not responsible for any inadequate installation that may damage the integrity of the product.
Finishes other than Groël's Powercoat are not recommended for wet or humid environments.



Production processes follow ecological norms.



Mechanical guarantee far exceed 200.000 operational cycles



Made of solid brass



Powercoat LIFELONG GUARANTEE



Unlacquered