

groël

Soft

Ethereal movement of softness.

The Soft door handle design, with rounded profiles enhanced by its natural simplicity, is presented on a round rose. This Italian door handle design made in high quality forged brass is conceived for interior and exterior doors in several finishes, giving life and personality to your doors.

Available in 5 finishes.



SATIN BRASS / POLISHED BRASS



BROWN / SATIN BRASS



POLISHED CHROME



SATIN CHROME



POLISHED CHROME / SATIN CHROME

groël

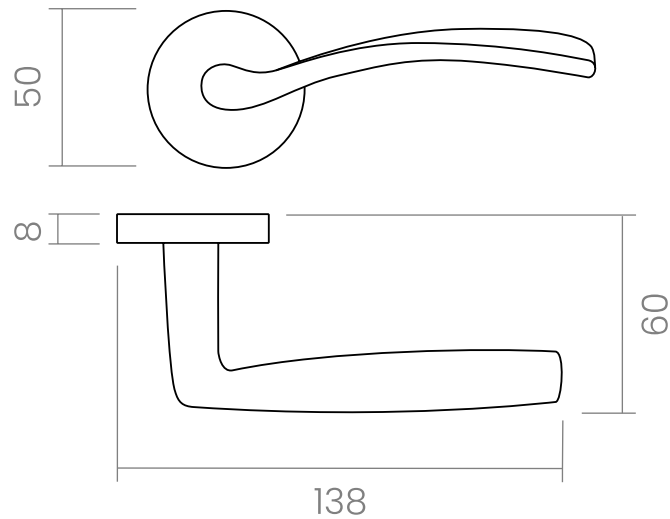









INFO. SPECIFICATIONS

Set of forged brass handles with an 8 mm thick round rose. Suitable for interior and exterior doors with a thickness between 35-50mm (Groël's standard size)* and with any type of lock.

For wider doors (50mm and above) and/or glass doors, please contact our customer service.

INFO. FINISHES & SKU

	LSLP Powercoat polished brass	807-R8-LSLP	
	MRLS Powercoat satin brass	807-R8-MRLS	
	CRCS Polished chrome / Satin chrome	807-R8-CRCS	
	CR Polished chrome	807-R8-CR	
	CS Satin chrome	807-R8-CS	

INFO. INCLUDED

- 2x** Lever handles with round rose
- 1x** Square spindle
- 1x** Bag of screws

INFO. CARE INSTRUCTIONS

Clean with a dry cloth. Do not use brass cleaner as it might affect the protective coating.

INFO. DISCLAIMER

Always seek the advice of professionals when installing these handles. Groël is not responsible for any inadequate installation that may damage the integrity of the product. Finishes other than Groël's Powercoat are not recommended for wet or humid environments.



Production processes follow ecological norms.



Mechanical guarantee far exceed 200.000 operational cycles



Made of solid brass



Chrome III 15 YEARS GUARANTEE



Varnish